

## 74VHC74 Dual D-Type Flip-Flop with Preset and Clear

### General Description

The VHC74 is an advanced high speed CMOS Dual D-Type Flip-Flop fabricated with silicon gate CMOS technology. It achieves the high speed operation similar to equivalent Bipolar Schottky TTL while maintaining the CMOS low power dissipation. The signal level applied to the D input is transferred to the Q output during the positive going transition of the CK pulse. CLR and PR are independent of the CK and are accomplished by setting the appropriate input LOW.

An input protection circuit ensures that 0V to 7V can be applied to the input pins without regard to the supply volt-

age. This device can be used to interface 5V to 3V systems and two supply systems such as battery backup. This circuit prevents device destruction due to mismatched supply and input voltages.

### Features

- High Speed:  $f_{MAX} = 170$  MHz (typ) at  $T_A = 25^\circ\text{C}$
- High noise immunity:  $V_{NIH} = V_{NIL} = 28\% V_{CC}$  (min)
- Power down protection is provided on all inputs
- Low power dissipation:  $I_{CC} = 2 \mu\text{A}$  (max) at  $T_A = 25^\circ\text{C}$
- Pin and function compatible with 74HC74

### Ordering Code:

Order Number	Package Number	Package Description
74VHC74M	M14A	14-Lead Small Outline Integrated Circuit (SOIC), JEDEC MS-120, 0.150" Narrow
74VHC74SJ	M14D	14-Lead Small Outline Package (SOP), EIAJ TYPE II, 5.3mm Wide
74VHC74MTC	MTC14	14-Lead Thin Shrink Small Outline Package (TSSOP), JEDEC MO-153, 4.4mm Wide
74VHC74N	N14A	14-Lead Plastic Dual-In-Line Package (PDIP), JEDEC MS-001, 0.300" Wide

Surface mount packages are also available on Tape and Reel. Specify by appending the suffix letter "X" to the ordering code.

### Logic Symbol

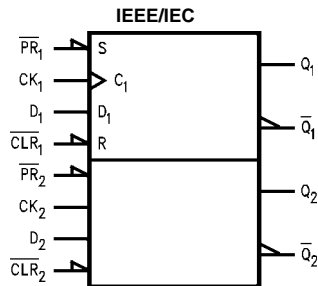

### Connection Diagram

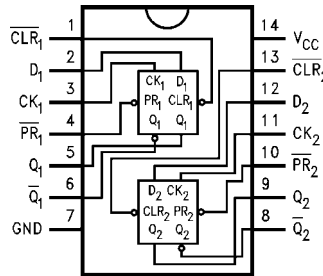

### Pin Descriptions

Pin Names	Description
$D_1, D_2$	Data Inputs
$CK_1, CK_2$	Clock Pulse Inputs
$\overline{CLR}_1, \overline{CLR}_2$	Direct Clear Inputs
$\overline{PR}_1, \overline{PR}_2$	Direct Preset Inputs
$Q_1, \overline{Q}_1, Q_2, \overline{Q}_2$	Output

### Truth Table

Inputs				Outputs		Function
CLR	PR	D	CK	Q	$\overline{Q}$	
L	H	X	X	L	H	Clear Preset
H	L	X	X	H	L	
L	L	X	X	H (Note 1)	H (Note 1)	
H	H	L	↗	L	H	No Change
H	H	H	↗	H	L	
H	H	X	↘	$Q_n$	$Q_n$	

**Note 1:** This configuration is nonstable; that is, it will not persist when pre-set and clear inputs return to their inactive (HIGH) state.

**Absolute Maximum Ratings** (Note 2)

Supply Voltage ( $V_{CC}$ )	-0.5V to +7.0V
DC Input Voltage ( $V_{IN}$ )	-0.5V to +7.0V
DC Output Voltage ( $V_{OUT}$ )	-0.5V to $V_{CC} + 0.5V$
Input Diode Current ( $I_{IK}$ )	-20 mA
Output Diode Current ( $I_{OK}$ )	$\pm 20$ mA
DC Output Current ( $I_{OUT}$ )	$\pm 25$ mA
DC $V_{CC}/GND$ Current ( $I_{CC}$ )	$\pm 50$ mA
Storage Temperature ( $T_{STG}$ )	-65°C to +150°C
Lead Temperature ( $T_L$ )	
Soldering (10 seconds)	260°C

**Recommended Operating Conditions** (Note 3)

Supply Voltage ( $V_{CC}$ )	2.0V to 5.5V
Input Voltage ( $V_{IN}$ )	0V to +5.5V
Output Voltage ( $V_{OUT}$ )	0V to $V_{CC}$
Operating Temperature ( $T_{OPR}$ )	-40°C to +85°C
Input Rise and Fall Time ( $t_r, t_f$ )	
$V_{CC} = 3.3V \pm 0.3V$	0 ~ 100 ns/V
$V_{CC} = 5.0V \pm 0.5V$	0 ~ 20 ns/V

**Note 2:** Absolute maximum ratings are values beyond which the device may be damaged or have its useful life impaired. The databook specifications should be met, without exception, to ensure that the system design is reliable over its power supply, temperature, and output/input loading variations. Fairchild does not recommend operation outside databook specifications.

**Note 3:** Unused inputs must be held HIGH or LOW. They may not float.

**DC Electrical Characteristics**

Symbol	Parameter	$V_{CC}$ (V)	$T_A = 25^\circ\text{C}$			$T_A = -40^\circ\text{C to } +85^\circ\text{C}$		Units	Conditions	
			Min	Typ	Max	Min	Max			
$V_{IH}$	HIGH Level Input Voltage	2.0 3.0 – 5.5	1.50 0.7 $V_{CC}$			1.50 0.7 $V_{CC}$		V		
$V_{IL}$	LOW Level Input Voltage	2.0 3.0 – 5.5			0.50 0.3 $V_{CC}$	0.50 0.3 $V_{CC}$		V		
$V_{OH}$	HIGH Level Output Voltage	2.0	1.9	2.0		1.9		V	$V_{IN} = V_{IH}$ or $V_{IL}$	$I_{OH} = -50 \mu\text{A}$
		3.0	2.9	3.0		2.9				
		4.5	4.4	4.5		4.4		V		$I_{OH} = -4 \text{ mA}$ $I_{OH} = -8 \text{ mA}$
		3.0	2.58			2.48				
4.5	3.94			3.80						
$V_{OL}$	LOW Level Output Voltage	2.0		0.0	0.1		0.1	V	$V_{IN} = V_{IH}$ or $V_{IL}$	$I_{OL} = 50 \mu\text{A}$
		3.0		0.0	0.1		0.1			
		4.5		0.0	0.1		0.1	V		$I_{OL} = 4 \text{ mA}$ $I_{OL} = 8 \text{ mA}$
		3.0			0.36		0.44			
4.5			0.36		0.44					
$I_{IN}$	Input Leakage Current	0 – 5.5			$\pm 0.1$	$\pm 1.0$		$\mu\text{A}$	$V_{IN} = 5.5V$ or GND	
$I_{CC}$	Quiescent Supply Current	5.5			2.0	20.0		$\mu\text{A}$	$V_{IN} = V_{CC}$ or GND	

AC Electrical Characteristics									
Symbol	Parameter	V <sub>CC</sub> (V)	T <sub>A</sub> = 25°C			T <sub>A</sub> = -40°C to +85°C		Units	Conditions
			Min	Typ	Max	Min	Max		
f <sub>MAX</sub>	Maximum Clock Frequency	3.3 ± 0.3	80	125		70		MHz	C <sub>L</sub> = 15 pF
			50	75		45			C <sub>L</sub> = 50 pF
		5.0 ± 0.5	130	170		110		MHz	C <sub>L</sub> = 15 pF
			90	115		75			C <sub>L</sub> = 50 pF
t <sub>PLH</sub>	Propagation Delay Time (CK-Q, $\bar{Q}$ )	3.3 ± 0.3		6.7	11.9	1.0	14.0	ns	C <sub>L</sub> = 15 pF
				9.2	15.4	1.0	17.5		C <sub>L</sub> = 50 pF
t <sub>PHL</sub>		5.0 ± 0.5		4.6	7.3	1.0	8.5	ns	C <sub>L</sub> = 15 pF
				6.1	9.3	1.0	10.5		C <sub>L</sub> = 50 pF
t <sub>PLH</sub>	Propagation Delay Time (CLR, PR -Q, $\bar{Q}$ )	3.3 ± 0.3		7.6	12.3	1.0	14.5	ns	C <sub>L</sub> = 15 pF
				10.1	15.8	1.0	18.0		C <sub>L</sub> = 50 pF
t <sub>PHL</sub>		5.0 ± 0.5		4.8	7.7	1.0	9.0	ns	C <sub>L</sub> = 15 pF
				6.3	9.7	1.0	11.0		C <sub>L</sub> = 50 pF
C <sub>IN</sub>	Input Capacitance			4	10		10	pF	V <sub>CC</sub> = Open
C <sub>PD</sub>	Power Dissipation Capacitance			25				pF	(Note 4)

**Note 4:** C<sub>PD</sub> is defined as the value of the internal equivalent capacitance which is calculated from the operating current consumption without load. Average operating current can be obtained from the equation: I<sub>CC (opr.)</sub> = C<sub>PD</sub> \* V<sub>CC</sub> \* f<sub>IN</sub> + I<sub>CC/2</sub> (per F/F).

AC Operating Requirements							
Symbol	Parameter	V <sub>CC</sub> (V) (Note 5)	T <sub>A</sub> = 25°C		T <sub>A</sub> = -40°C to +85°C		Units
			Typ	Guaranteed Minimum			
t <sub>W(L)</sub>	Minimum Pulse Width (CK)	3.3		6.0	7.0	ns	
t <sub>W(H)</sub>		5.0		5.0	5.0		
t <sub>W(L)</sub>	Minimum Pulse Width (CLR, PR)	3.3		6.0	7.0	ns	
		5.0		5.0	5.0		
t <sub>S</sub>	Minimum Setup Time	3.3		6.0	7.0	ns	
		5.0		5.0	5.0		
t <sub>H</sub>	Minimum Hold Time	3.3		0.5	0.5	ns	
		5.0		0.5	0.5		
t <sub>REC</sub>	Minimum Recovery Time (CLR, PR)	3.3		5.0	5.0	ns	
		5.0		3.0	3.0		

**Note 5:** V<sub>CC</sub> is 3.3 ± 0.3V or 5.0 ± 0.5V

**Physical Dimensions** inches (millimeters) unless otherwise noted

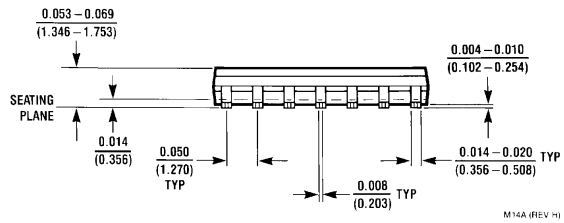
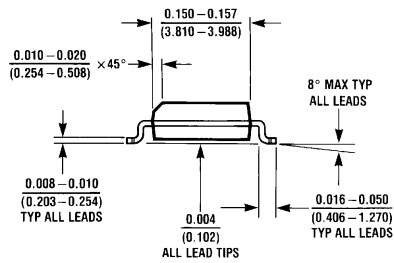
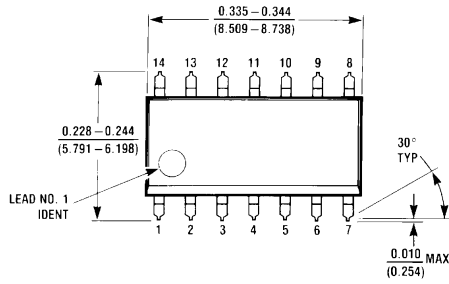

M14A (REV H)

**14-Lead Small Outline Integrated Circuit (SOIC), JEDEC MS-120, 0.150" Narrow  
Package Number M14A**

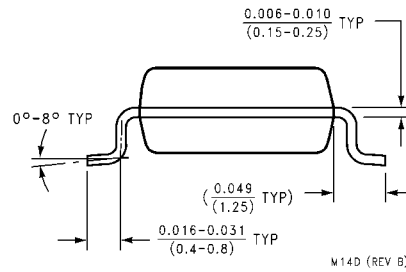
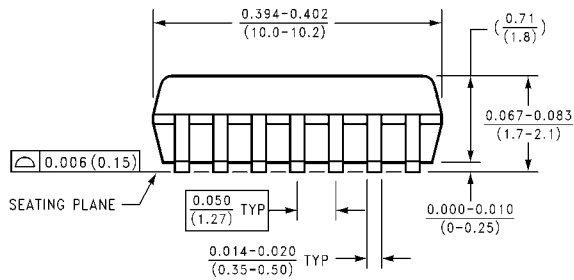
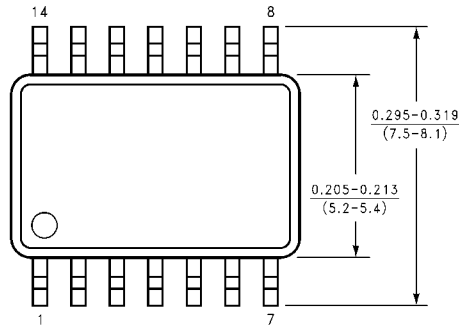

M14D (REV B)

**14-Lead Small Outline Package (SOP), EIAJ TYPE II, 5.3mm Wide  
Package Number M14D**

**Physical Dimensions** inches (millimeters) unless otherwise noted (Continued)

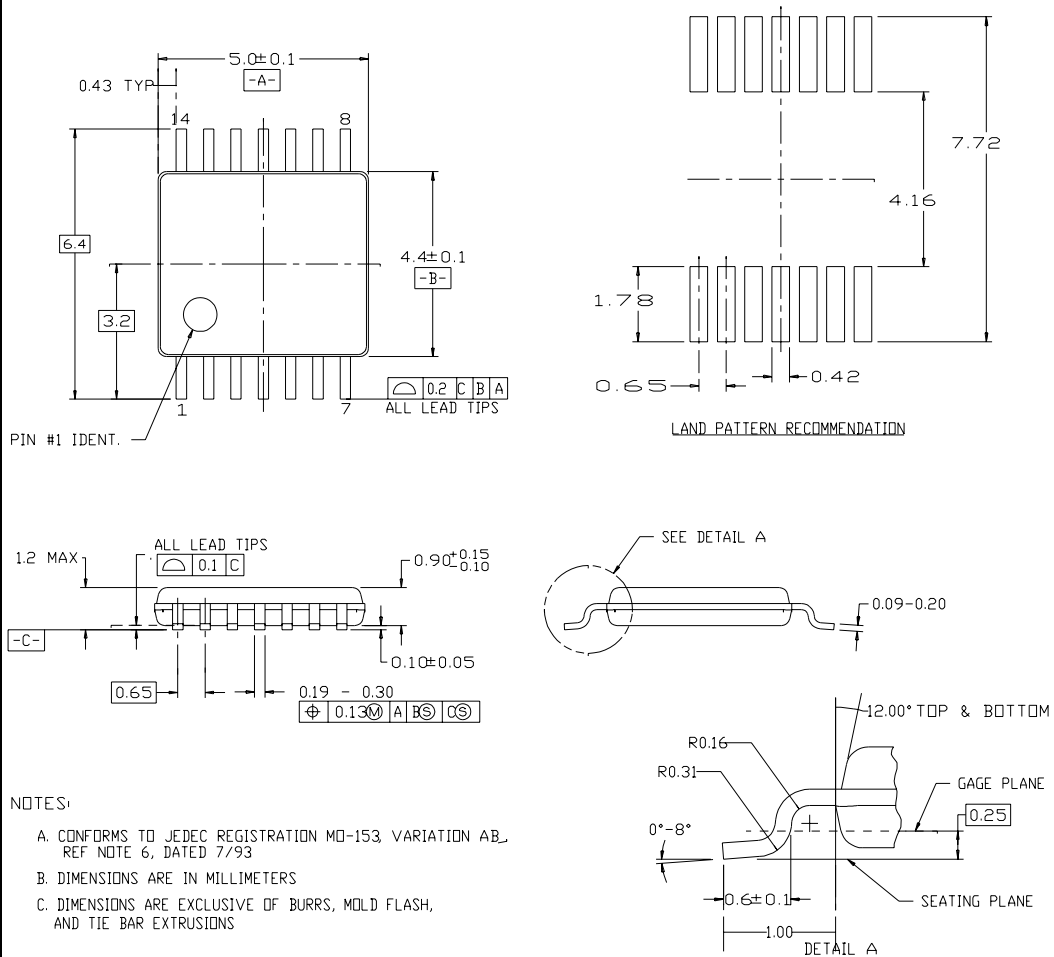

**14-Lead Thin Shrink Small Outline Package (TSSOP), JEDEC MO-153, 4.4mm Wide  
Package Number MTC14**

**Physical Dimensions** inches (millimeters) unless otherwise noted (Continued)



**LIFE SUPPORT POLICY**

FAIRCHILD'S PRODUCTS ARE NOT AUTHORIZED FOR USE AS CRITICAL COMPONENTS IN LIFE SUPPORT DEVICES OR SYSTEMS WITHOUT THE EXPRESS WRITTEN APPROVAL OF THE PRESIDENT OF FAIRCHILD SEMICONDUCTOR CORPORATION. As used herein:

1. Life support devices or systems are devices or systems which, (a) are intended for surgical implant into the body, or (b) support or sustain life, and (c) whose failure to perform when properly used in accordance with instructions for use provided in the labeling, can be reasonably expected to result in a significant injury to the user.
2. A critical component in any component of a life support device or system whose failure to perform can be reasonably expected to cause the failure of the life support device or system, or to affect its safety or effectiveness.

[www.fairchildsemi.com](http://www.fairchildsemi.com)